

**DRM270730LT****Weidmüller Interface GmbH & Co. KG**

Klingenbergstraße 26

D-32758 Detmold

Germany

www.weidmueller.com

**Product image**

Similar to illustration

Individual relays within the D-SERIES DRM

- 2 CO contacts
- AC coils
- With integrated status LED and test button

**General ordering data**

Version	D-SERIES DRM, Relay, Number of contacts: 2, CO contact, AgNi flash gold-plated, Rated control voltage: 230 V AC, Continuous current: 10 A, Plug-in connection
Order No.	<a href="#">7760056076</a>
Type	DRM270730LT
GTIN (EAN)	4032248855797
Qty.	20 pc(s).

Creation date July 12, 2023 12:34:31 AM CEST

Catalogue status 07.07.2023 / We reserve the right to make technical changes.

## DRM270730LT

**Weidmüller Interface GmbH & Co. KG**

Klingenbergstraße 26

D-32758 Detmold

Germany

www.weidmueller.com

## Technical data

### Dimensions and weights

Depth	35.7 mm	Depth (inches)	1.406 inch
Height	27.4 mm	Height (inches)	1.079 inch
Width	21 mm	Width (inches)	0.827 inch
Net weight	34.9 g		

### Temperatures

Storage temperature	-40 °C...70 °C	Operating temperature	-40 °C...55 °C
Operating temperature, min.	-40 °C	Operating temperature, max.	55 °C
Humidity	35...85 % rel. humidity, no condensation		

### Rated data UL

Certificate No. (cURus)	E312083
-------------------------	---------

### Control side

Rated control voltage	230 V AC	Rated current AC	6.1 mA (50 Hz), 5.2 mA (60 Hz)
Power rating	1.0...1.2VA (60HZ)	Pull-in/drop-out voltage, typ.	184 V / 69 V AC
Coil resistance	16000 Ω ± 10 %	Coil tolerance	10 %
Status indicator	red LED		

### Load side

Rated switching voltage	250 V AC	Continuous current	10 A
Max. switching frequency at rated load	0.1 Hz	Inrush current	20 A / 50 ms
AC switching capacity (resistive), max.	2500 VA	DC switching capacity (resistive), max.	240 W @ 24 V
Switch-on delay	< 20 ms	Switch-off delay	< 20 ms
Contact type	2 CO contact (AgNi flash gold-plated)	Mechanical service life	20 x 10 <sup>6</sup> switching cycles
Min. switching power	10 mA @ 12 V, 100 mA @ 5 V		

### General data

Test button available	Yes	
Version of test button	Lockable test button, Momentary test button	
Mechanical switch position indicator	Yes	
Colour	Transparent	
UL94 flammability rating component	Component	Relay cover
	UL94 flammability rating	V-2
	Component	Relay baseplate
	UL94 flammability rating	V-0
	Component	Relay status indicator
	UL94 flammability rating	HB
Component	Relay test button	
	UL94 flammability rating	HB

**DRM270730LT****Weidmüller Interface GmbH & Co. KG**

Klingenbergstraße 26

D-32758 Detmold

Germany

www.weidmueller.com

**Technical data****Insulation coordination**

Rated voltage	250 V	Pollution severity	2
Surge voltage category	III	Clearance and creepage distances for control side - load side	≥ 5.5 mm
Dielectric strength for control side - load side	1.8 kV <sub>eff</sub> / 1 min.	Dielectric strength of neighbouring contacts	1 kV <sub>eff</sub> / 1 min
Dielectric strength of open contact	1 kV <sub>eff</sub> / 1 min	Impulse withstand voltage	6 kV (1.2/50 μs)
Protection degree	IP20		

**Further details of approvals / standards**

Certificate No. (cURus) E312083

**Connection data**

Wire connection method Plug-in connection

**Classifications**

ETIM 6.0	EC001437	ETIM 7.0	EC001437
ETIM 8.0	EC001437	ECLASS 9.0	27-37-16-01
ECLASS 9.1	27-37-16-01	ECLASS 10.0	27-37-16-01
ECLASS 11.0	27-37-16-01	ECLASS 12.0	27-37-16-01

**Environmental Product Compliance**

REACH SVHC Lead 7439-92-1

**Approvals**

Approvals



ROHS	Conform
UL File Number Search	UL Website
Certificate No. (cURus)	E312083

**Downloads**

Approval/Certificate/Document of Conformity	<a href="#">EU Konformitätserklärung / EU Declaration of Conformity</a>
Engineering Data	<a href="#">CAD data – STEP</a>
Engineering Data	<a href="#">WSCAD, Zuken E3.S, EPLAN</a>
Product Change Notification	<a href="#">20230124 Product consolidation D-SERIES DRM relays</a> <a href="#">20230124 Produktkonsolidierung D-SERIES DRM Relais</a>
Catalogues	<a href="#">Catalogues in PDF-format</a>
Brochures	

DRM270730LT

Weidmüller Interface GmbH & Co. KG  
 Klingenbergstraße 26  
 D-32758 Detmold  
 Germany

www.weidmueller.com

Drawings

Wiring diagram

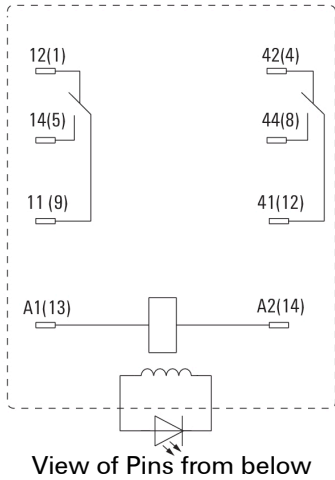

Graph

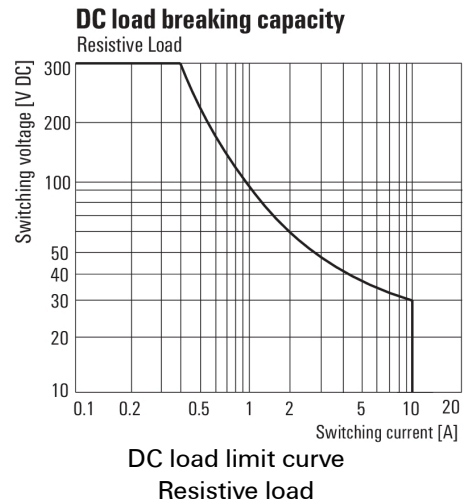

Graph

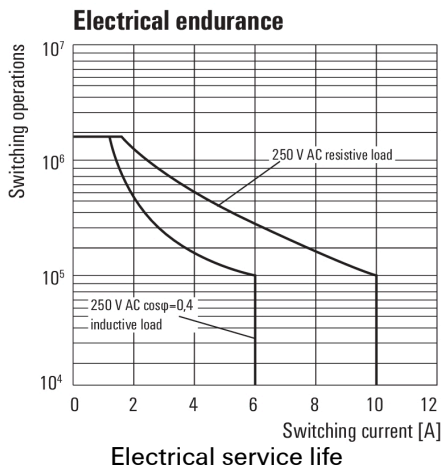

Graph

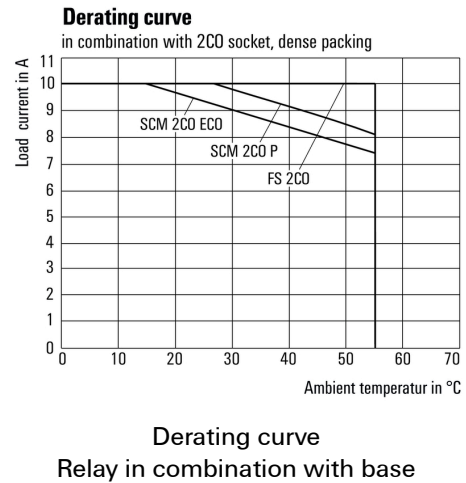

Graph

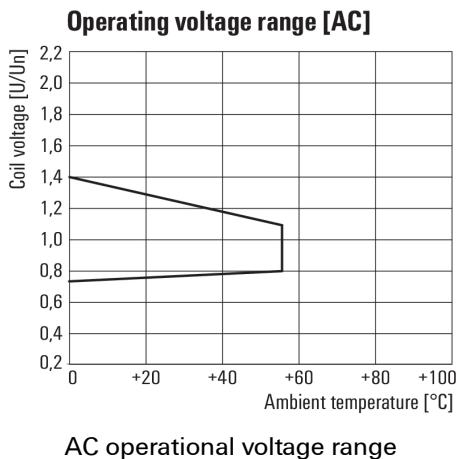

Dimensional drawing

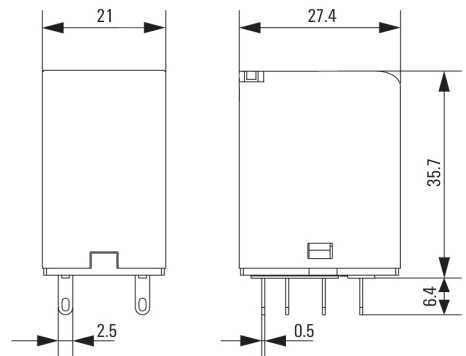

**Data sheet**

**DRM270730LT**

**Weidmüller Interface GmbH & Co. KG**  
 Klingenbergstraße 26  
 D-32758 Detmold  
 Germany

www.weidmueller.com

**Drawings**

**Miscellaneous**

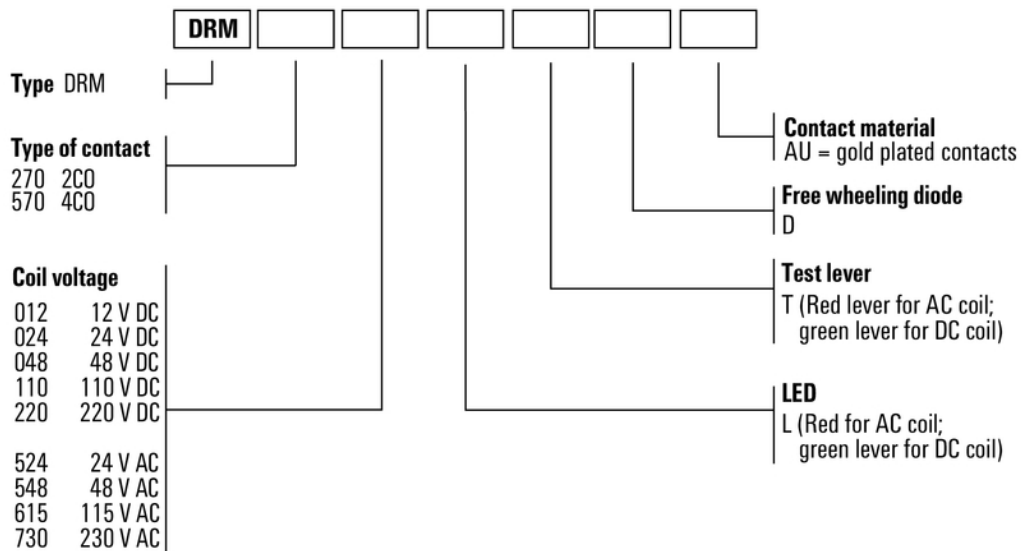

Type codes